

UPVC WINDOWS  
& DOORS

*welcome home*

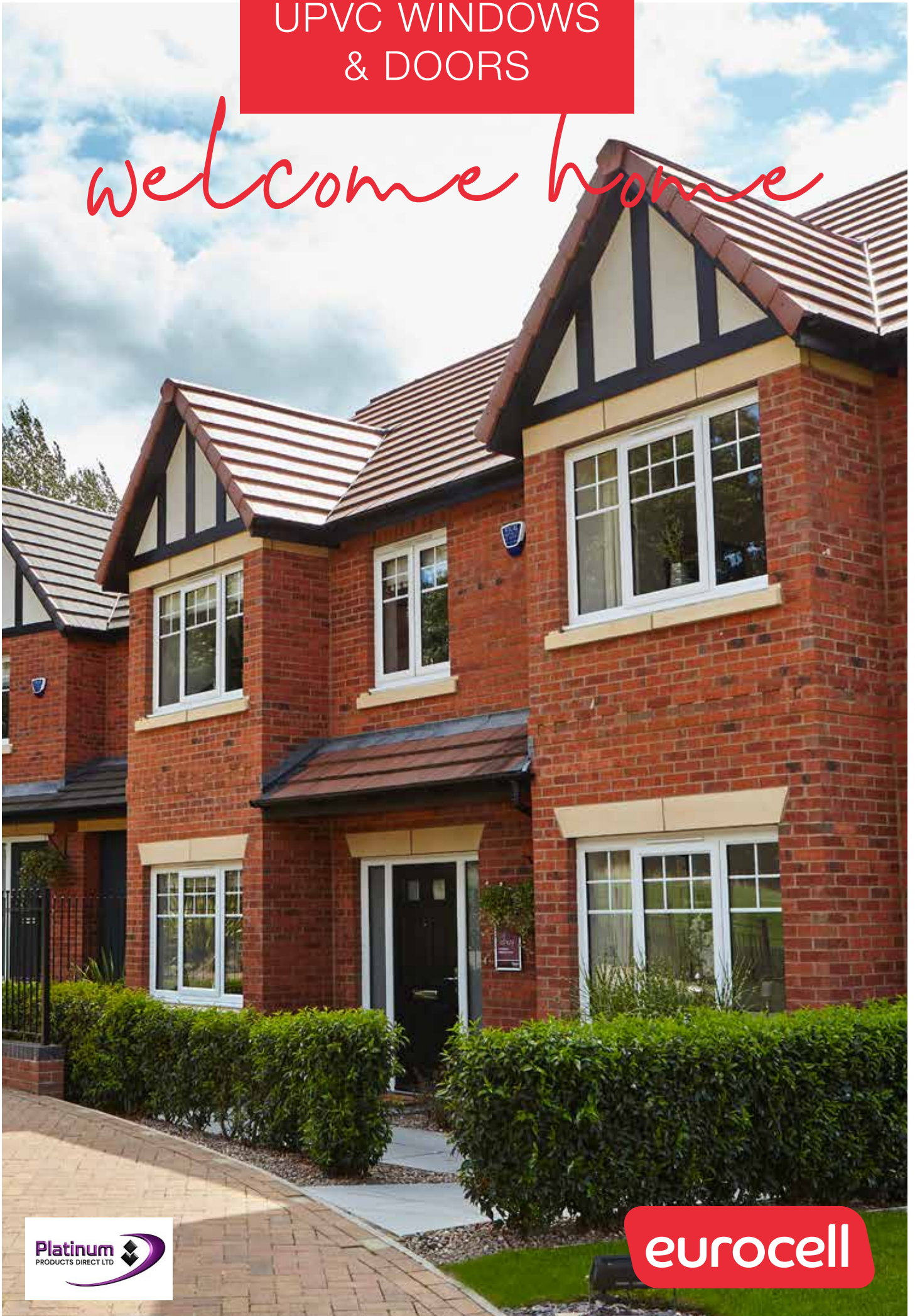

## Welcome to quality windows & doors *window on your world*

WELCOME TO QUALITY WINDOWS & DOORS	2
THE SUSTAINABLE CHOICE	6
ULTIMATE ENERGY EFFICIENCY	8
STRENGTH AND SECURITY	10
WINDOWS	12
UPVC DOORS	28
COLOUR YOUR WORLD	34
PEACE OF MIND	35

The look and style of your home says a great deal about you. Doors and windows are a prominent feature on any property and really dictate the character of your home. As well as creating a first impression for visitors, they play a crucial role in weather-proofing, insulating and securing your property.

Installing high-quality UPVC doors and windows is the best-value home improvement you can make. At a stroke you can improve the appearance, energy efficiency and security of your home – all at an affordable cost.

Front cover image:  
Ovolo casement windows  
in White with Georgian bars

WELCOME



### Styles to suit every home

We can create a complete range of window and door types to suit any home. From classic casement windows to innovative tilt and turn styles, French windows, bay windows and entrance doors.

Chamfered casement windows in White



Chamfered French doors in Anthracite Grey with sidelights



Privacy windows Chamfered in White

WELCOME



Ovolo casement windows  
in White with Georgian bars

## Add value *to your home*

### Colour-match guarantee

Because all our frames are produced by the same manufacturer – Eurocell – we can assure you that all colours are exactly matched across our entire range of window and door products. It means that our whites are the same white across all products and our woodgrain finishes are all perfectly matched. No matter what the age, style or size of your property, we can create high quality windows and doors to enhance and add value to your home.

### High-security system

Our UPVC windows and doors are durable and robust, giving long-life, low-maintenance performance, with no need for painting or other treatments. They are fitted with high security locking mechanisms and tested to PAS24 and Secured by Design enhanced security standards, giving you the peace of mind that your home is well protected against intruders.

*multi-chambered  
frame design*

### Energy efficient design

The multi-chambered frame designs deliver exceptional energy efficiency for both windows and doors – helping to keep your home warm and comfortable all year round, as well as reducing your energy consumption. Our slim frames also allow the area of glass in windows to be optimised, maximising the amount of natural light within your home.



THE SUSTAINABLE  
CHOICE



## The Sustainable Choice

*made & recycled  
in the UK*

For many years, UPVC windows and doors have been recognised as the durable, low maintenance and energy efficient option. Now, thanks to recent advances in recycling, UPVC windows and doors are the first choice material for sustainability too. It means that choosing to buy your UPVC windows and doors from us is good for your home, your pocket and the environment.

### 'A' rated for sustainability

Eurocell, which manufactures all of the UPVC components used in our windows and doors, is at the forefront of sustainable developments in the UPVC industry. The company recycles over 3 million waste window frames per year which would otherwise go to landfill. The material is used to manufacture brand new windows, for closed-loop material sustainability.

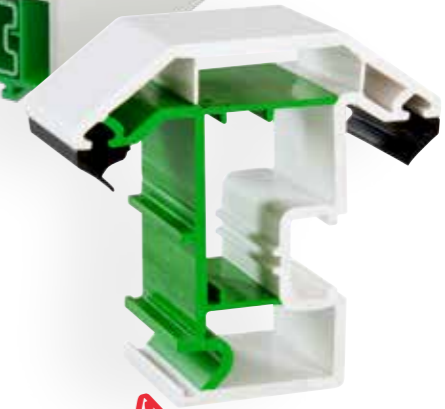
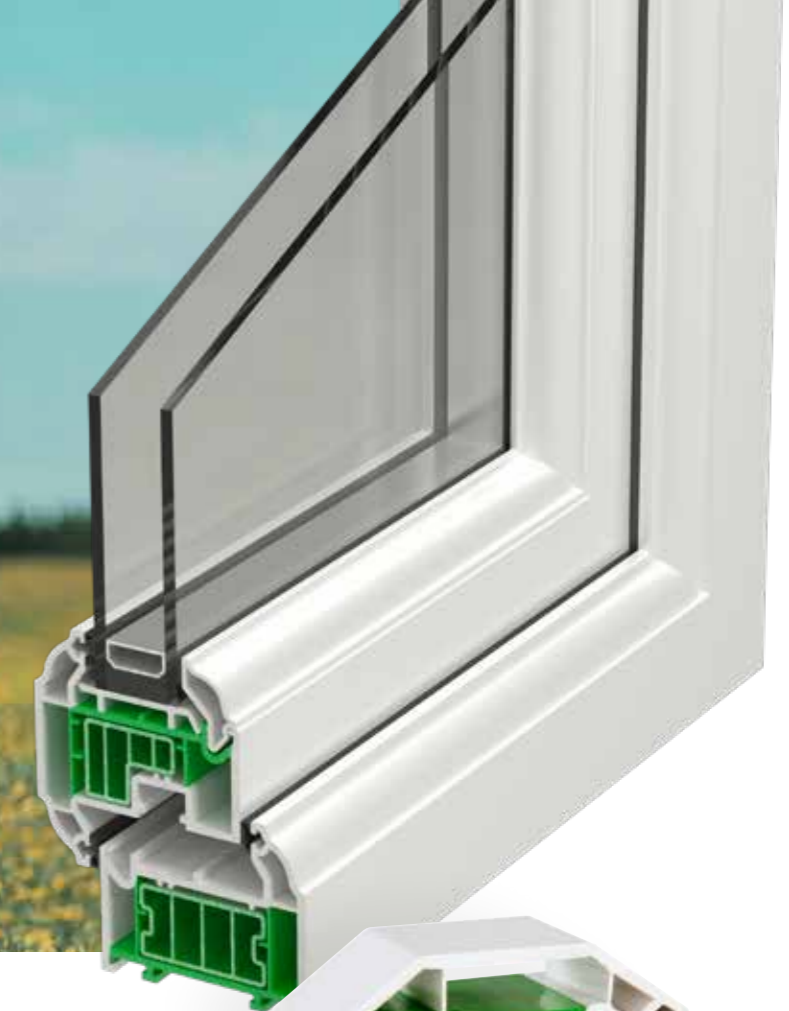

### Reuseable and recyclable for hundreds of years

Research has shown that 95% of 'post-consumer' or end-of-life UPVC windows can be recycled. According to the Building Research Establishment (BRE), the life cycle for a UPVC window or door is up to 35 years and they can be recycled up to 10 times. This means UPVC has a life of 350 years of re-use with minimal impact on the environment.

### Environmentally responsible component supplier

Our windows represent a genuine sustainable option. Not only because they help reduce CO<sub>2</sub> emissions, but also because UPVC is a fully recyclable material. Each year, tens of thousands of tonnes of UPVC are recycled, minimising impact on landfill waste sites.

*made with  
recycled  
content*

Coloured content shown for illustrative purposes.

Sustainability awards won by our  
UPVC profiles partner Eurocell



# ULTIMATE ENERGY EFFICIENCY

## Ultimate energy efficiency

*cool in summer,  
warm in winter*

### Built-in thermal efficiency

Our window frames feature an advanced multi-chambered cross-section which helps to prevent heat loss and enhance thermal efficiency. This means we can create windows that meet the highest energy efficiency ratings.

### Windows that make the grade

Window Energy Ratings are a simple, clear and easily understood method of informing customers of the relative energy efficiency of a particular window. The windows are rated on an 'A++' to 'E' scale, which is consistent with other products such as lightbulbs and white goods. An 'A++' rating signifies the most energy-efficient products, a 'E' the least efficient. Current Building Regulations require a 'B' rating for replacement windows. Our windows can be designed to achieve any rating on this scale, according to your needs and budget. If you're looking for low U-values, our windows can achieve as low as 0.9 W/m<sup>2</sup>K\* with Building Regulations for replacement windows requiring a U-value of 1.4 W/m<sup>2</sup>K.

\*with triple-glazing and Argon gas

### Comfortable homes with lower running costs

Windows have a vital role to play in conserving energy in buildings, since 10% of the heat escaping from an average home is lost through its windows.\* Choosing the right combination of glazing and window frames is essential to improve the energy efficiency of your home, reduce your energy costs and, crucially, create a comfortable living environment for you and your family – all year round.



### Good for your pocket – and the planet

Conserving energy in our homes is essential to help reduce energy bills and protect the environment by cutting carbon dioxide emissions. The fact that our homes and buildings are responsible for almost half of the UK's carbon dioxide emissions means that improving energy efficiency in all dwellings is a top priority for the Government and homeowners alike.



### Window Energy Ratings

Windows and doors rated on an A++ to E scale

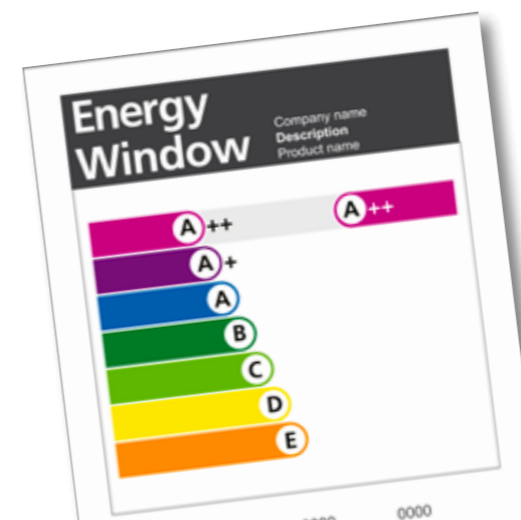

# A++

*a positive contribution*

Any windows or door with a WER of 'A' or higher makes a positive energy contribution to your home

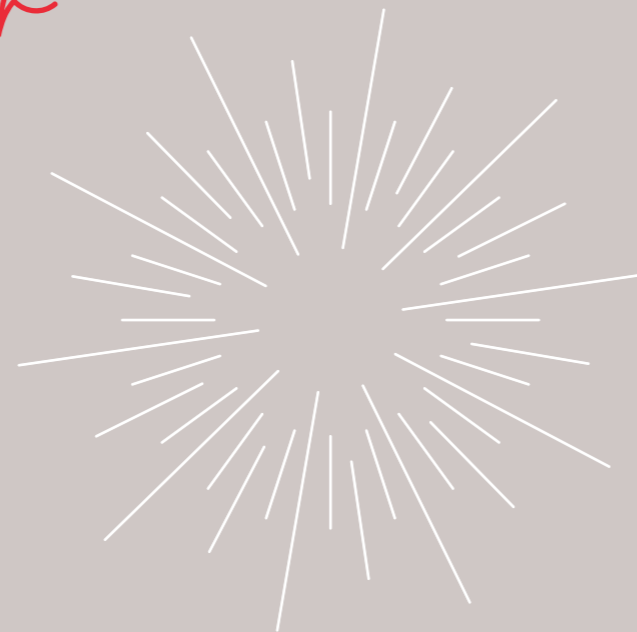

## STRENGTH & SECURITY



Chamfered casement windows in White



## Strength & security *feel safe and secure*

*a range of security options including reinforced frames*

### Protect your property

Your windows play a crucial role in securing your home against unwanted intruders. In addition to being secure, they need to be robust and durable enough to withstand the wear and tear of everyday use – as well as everything the British weather can throw at them, which is why our products are tested to BS 6375-1 covering air permeability, water tightness and wind resistance.

### Low maintenance option

One of the principal benefits of UPVC windows over any other material is that they require no maintenance, other than the occasional wipe down with a damp cloth – no painting, no preservative treatments, no hassle.

### Safe and secure

Protecting your property against unwanted intruders is a primary concern for every homeowner. That's why our windows have been designed to deter burglars and secure your property against forced entry. For a start, all of our windows are internally beaded, which means the glazing units cannot be removed from the outside.

That's a major deterrent to burglars. What's more, our windows and doors are tested to PAS24 Secured by Design standards and can be fitted with the most advanced security hardware on the market, including shoot bolts, locking handles, heavy-duty security hinges and hinge guards.

# WINDOWS



Chamfered casement windows  
in Anthracite Grey



Ovolo

... sculptured



Chamfered

... straight edge

## Windows

are the showcase feature of your home

framed in style

**Our windows are available with three distinctive styles of frame and beading.**

### Refresh your outlook on the world

Windows are the showcase feature of your home. They determine the character and appearance of your property, whether it's a chic apartment, a traditional Victorian terrace or a stylish new-build house. Windows frame your view of the world from within and define the appearance of your home from the outside.

It's essential to choose windows that complement the style of your home, provide long-life protection against the elements and enhance the security of your property. With our versatile UPVC windows, you can rest assured that you will find an attractive, secure, energy-efficient style to suit your home.

### A question of aesthetics

The contemporary styling of our UPVC windows includes a slimmer frame, giving a sleek, unobtrusive appearance and maximising the area of glass in your windows. That means more natural light in your home and a clearer view of the outdoors for you.

The aesthetics of your window can be enhanced to match the architectural style of your home with a range of stylish accessories. Georgian bars, mock horn sashes and arch-top inserts can help you to create an individual look that perfectly complements your property.

The chamfered option is a contemporary, straight-edged style, while ovolo sculptured beading gives a more traditional, decorative finish to your window.

Both chamfered and ovolo options are available across our entire range of windows, giving you complete flexibility to select your preferred style. You can even mix and match chamfered and ovolo glazing beads to create a unique style all of your own.

The flush sash option offers a smooth, streamlined finish to any new build project. It's also the perfect replacement window to give a contemporary upgrade to older homes.



Flush Sash

... square

# The flush sash window

*a new look and style for your home*

Most of the windows you see when you look around are designed with either the popular chamfered or ovolo frames. Now, there's a third style to choose from – the flush sash frame.

Like the name suggests, these windows offer a smooth, flush fitting appearance when closed, with no lip between the outer frame and the sash. When finished in Grey, the result is a modern, streamlined look that's growing in popularity, especially in more modern home designs. For a more traditional timber look choose a woodgrain finish to perfectly complement the aesthetics of your property.



**Flush sash window**  
in Anthracite Grey



*smooth flush fitting*

Our flush sash windows offer superb heat and noise insulation, security and strength as standard

Logik flush sash frames are available in a wide range of woodgrain colour finishes. In fact, they're so realistic, it's hard to tell from the kerbside that they're not actual wood frames.

**Flush sash window**  
in Anteak

# WINDOWS

## The grey revolution

*get the all-grey aluminium look*

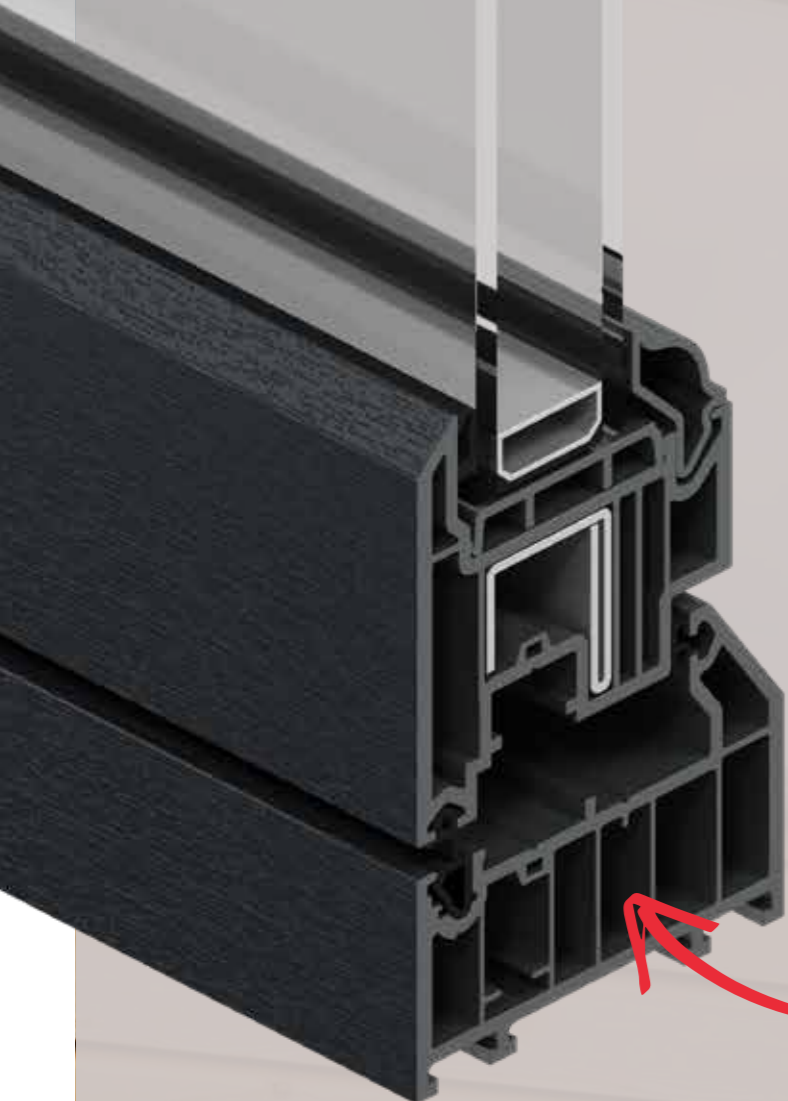

What is really special, is our grey substrate option. With a grey external foil and grey substrate, the window is the same colour all the way through.

A great way to get the all-grey aluminium look that's getting more and more popular nowadays, without paying the premium price of aluminium itself.

*for the consistent look even with the window open*



Chamfered windows & Entrance doors in Anthracite Grey



*... a great way to get the all-grey aluminium look!*

# WINDOWS

Chamfered windows  
& French doors  
in Anthracite Grey



## Styles to suit every home

*a welcome complement*

Whether you live in a contemporary city-centre flat, a suburban semi-detached or a quaint country cottage, we offer a window style and features like Georgian bars, to enhance your home and complement its individual character.



CASEMENT WINDOWS



TILT AND TURN\*



BOW & BAY WINDOWS



FRENCH WINDOWS

\* Not available in Logik flush sash

# WINDOWS

## Casement Windows

*Simple and functional design*

*a choice of opening options*

This simple and functional window design is ideal for all types of property. It is the most popular and widely used style of window in the UK. Our casement windows can be either top-hung opening or side-hung opening to suit your requirements, providing excellent ventilation and security. You can choose clean-cut chamfered beading, a more decorative sculpted ovolo finish, or a flush sash for a modern look, according to your tastes, and consider internal or external Georgian bars.

Right:  
**Ovolo casement windows**  
in Cream with Georgian bars

Below:  
**Ovolo casement windows & entrance doors**  
in Irish Oak



## Tilt & Turn Windows

*sophisticated window style*



### Versatile openings

This sophisticated window style is becoming increasingly popular. It combines the benefits of a large area of glass with ease of cleaning and excellent ventilation.

The innovative tilt and turn mechanism enables the window to be opened inwards from the top for effective ventilation or from the side for safe and easy cleaning from within your home.



*safe and easy cleaning*

Tilt & Turn windows  
in Moondust Grey

## Bay & Bow Windows

*functional freedom*

### Functional freedom

Whether your home features traditional bay or more modern bow-style windows, we can create high-performance, draught-free and secure windows for you. Bay and bow windows open your room up to the outdoors, creating a feeling of space and light. We can enhance this effect by installing slim-framed windows that maximise your glazing area and flood your home with natural light.

Right  
Chamfered bay window  
in White with Georgian bars

Below  
Ovolo bay window  
in Black Ash



## French Windows

*traditionally simple*



Whether you want simple understated windows, a natural wooden look or want to make a bold statement, we offer the colour options and finishes to suit your preferences.

This double-opening window perfectly complements cottage-style properties. With twin opening sashes it allows you to invigorate your home with fresh air and really let the outside in – whilst providing an effective means of fire escape from upper floors. Advanced locking mechanisms means you can now create traditional cottage looks without compromising on security.

Other colours are available by special order, giving you unlimited scope to create the window style of your choice.

*traditional cottage looks*

**Chamfered French window** in Cream

## Flush Sash French Window

*enhanced aesthetics*

An externally flush sash offers enhanced aesthetics to rival that of traditional timber windows and our UPVC alternative delivers better thermal performance and energy rating than timber options with A++ available and U-values as low as 0.9 W/m<sup>2</sup>K.

The advantage of French windows is their ability to maximise natural light, as well as provide a bright and open feeling to any living space. This also contributes warmth during winter and reduces daytime energy spending on internal lighting.

*maximise natural light*

**Flush sash French window** in Agate Grey



# UPVC Doors

*new first impressions*

Your entrance door is the gateway to your home. It reflects your tastes and creates that all-important first impression. It's important that your entrance door complements the style of your property, but it also needs to be functional and secure – durable enough to withstand and everyday use and secure enough to protect your property against intruders.

Our entrance doors, constructed from the same robust UPVC components as our windows, are the perfect solution, combining aesthetic appeal with practicality and low maintenance.

## Low maintenance long-life solutions

Our entrance doors are designed for long-life performance, even in the busiest households where they are subjected to knocks and scrapes every day. With internal webbing and thick UPVC walls, our doors are designed to withstand the rigours of everyday use without scratching or denting.

Like our windows, our doors have been independently assessed and certified by the British Board of Agrément (BBA). All of our doors also come with a ten-year guarantee against discolouration, warping and cracking.

UPVC doors require minimal maintenance. They don't need to be painted or treated. Occasional wiping with a damp cloth is all they need to maintain a fresh, good-as new appearance. Furthermore, UPVC doesn't warp or crack like other materials, so you can be sure your door will maintain its original appearance and performance for years to come.

## Protection against intruders

Security is a primary function of any entrance door. Our doors are fitted with the latest generation of high-security locks to keep your property secure against break-ins. Multi-point locking systems are designed to prevent forced entry and all doors are internally beaded to prevent glazing units or UPVC panels being removed from the outside.

## Protection against the elements

UPVC doors offer exceptional protection against the elements. Air-tight seals keep out any drafts and effective drainage channels ensure there are no leaks. Our range of doors also offers excellent thermal efficiency, ensuring heat is retained in your home and helping to keep your energy bills down.



UPVC Entrance door  
Chamfered in White with toplight

*aesthetic appeal with practicality  
and low maintenance*



## UPVC DOORS



## Entrance Doors

*tailored to  
your needs*

You can choose from half-glazed or fully glazed doors, with panels and glazing in a range of styles and configurations. You can also add decorative touches, such as ovolo or chamfered beads and Georgian bars, to suit your home.

### Make a stylish entrance

Whatever your tastes and no matter what style of home you live in, we offer an entrance door to meet your requirements. Our durable, attractive UPVC doors are available in a huge variety of styles, colours and finishes.

*there's a style for  
every home*

UPVC Entrance Door  
Ovolo in Irish Oak with  
sidelights

## UPVC DOORS



## French Doors

*Let the fresh  
air in*

On a warm summer's day, there's nothing quite like throwing open your French doors and letting the fresh air and sunshine come flooding in. French doors are a more traditional style of door, full of charm and character and unlike timber, UPVC gives you more options to customise your French doors to your individual taste.

French doors are ideal for a wide range of uses and can be beautifully suited to open up conservatories or to make a unique design statement within your home, our doors have a classic appearance with all the benefits of contemporary UPVC double-glazing. They also bring some real benefits, including the latest security and superior energy efficiency.

For a smooth, seamless transition between outdoors and indoors, we can design your French doors with a low threshold. This enables easy access to your home particularly for push chairs and wheelchair users, meaning your doors are fully compliant with Part M Building Regulations.

# COLOUR YOUR WORLD

## Colour your world

*with a choice of contemporary & traditional styles*

With a choice of contemporary colours and styles, you can create a look that is perfect for your home.



**WHITE**  
White interior



**WHITE ASH†**  
Both sides



**CREAM**  
Cream interior



**IRISH OAK†**  
White interior

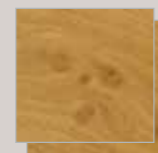

**IRISH OAK†**  
Both sides



**GOLDEN OAK**  
White interior



**GOLDEN OAK**  
Both sides

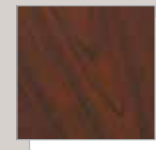

**ROSEWOOD**  
White interior

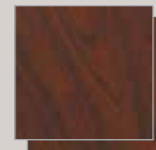

**ROSEWOOD**  
Both sides

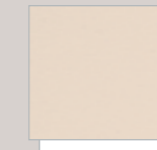

**CREAM WHITE†**  
White interior



**CHARTWELL GREEN**  
White interior



**AGATE GREY**  
White interior



**SLATE GREY\***  
White interior



**ANTHRACITE GREY SMOOTH\***  
White interior

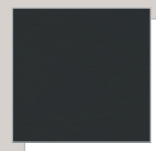

**ANTHRACITE GREY**  
White interior



**BLACK ASH\***  
White interior

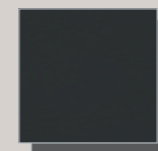

**ANTHRACITE GREY**  
Grey base

† Ovolo only \*Chamfered only  
Note: Anthracite Grey with Grey base features cool colours foil

# PEACE OF MIND

## Peace of mind

*included as standard*



**10-years guarantee**  
on the window and door profiles



**5-years guarantee**  
on the glass



**2-years guarantee**  
as a minimum on hardware



Family Run Business, Established 2013

**0800 002 9033 / 0330 111 9033**

open 7 days a week 9am - 8pm

[www.platinumproductsdirect.co.uk](http://www.platinumproductsdirect.co.uk)

[sales@platinumproductsdirect.co.uk](mailto:sales@platinumproductsdirect.co.uk)

